

Pyroelectric Linear Arrays HPL 128/HPL 256

with 128 or 256 elements and integrated CMOS multiplexer

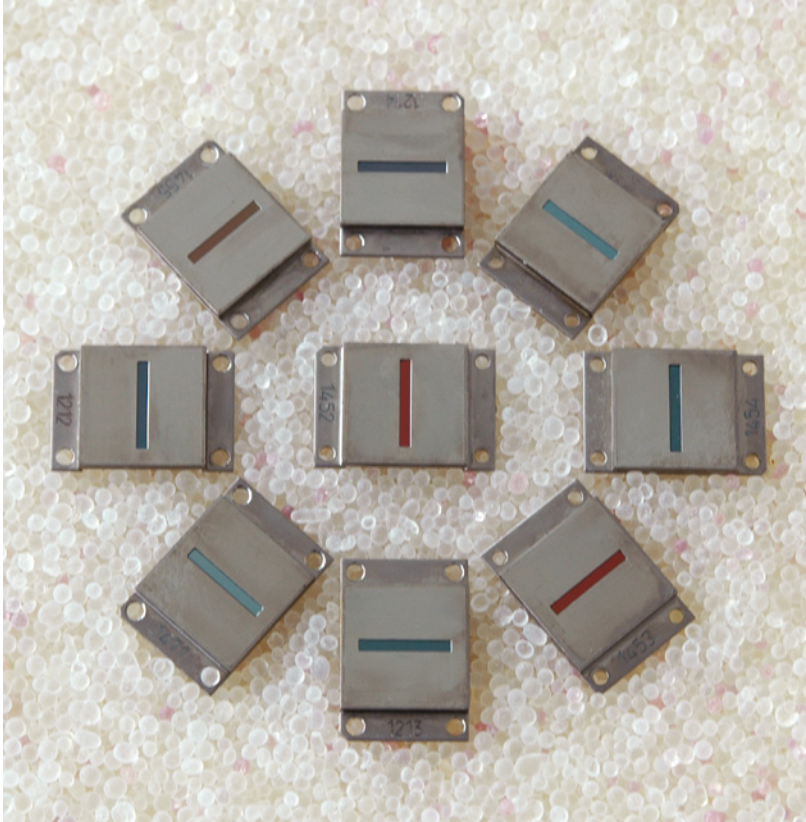

Features

- 128 or 256 elements arranged in one line
- NEP (128 Hz) down to 1.1 nW
- Dynamic range > 75 dB
- Modulation frequency up to 512 Hz
- Output voltage $2.5 \text{ V} \pm 2 \text{ V}$
- Integrated CMOS multiplexer
- High long-term stability
- Simple mode of operation
- Operation at ambient temperature
- Small package
- Coated silicon or germanium as infrared window
- Broad band windows ($> 1.4 \mu\text{m}$) or special filters are possible on request
- Customised arrays with up to 256 elements with special sizes

Description

The pyroelectric linear arrays HPL 128 and HPL 256 are hybrid detectors with 128 or 256 elements and an integrated CMOS multiplexer.

The pyroelectric chip is made from lithium tantalate (LiTaO_3) with pixel widths of $90 \mu\text{m}$ (HPL 128) or $42 \mu\text{m}$ (HPL 256) and lengths of $100 \mu\text{m}$, $500 \mu\text{m}$ or $1000 \mu\text{m}$.

The multiplexer includes low-noise preamplifiers for each pixel, analogue switches and an output amplifier. The preamplifiers transform the signal charges of each pixel into a signal voltage, include bandwidth limiting and pass the amplified signal to the sample & hold for the read-out process. The digital inputs are CMOS compatible.

For measurement of the detector temperature a sensor (type AD 590) is integrated into the package. It provides an output current which is proportional to the temperature.

The pyroelectric chip and the read-out circuit are arranged in a metal hermetic package with an infrared window which determines the spectral responsivity.

In common with all pyroelectric detectors, the incoming infrared radiation needs to be pulsed for a measurement to be made.

Typical applications can be found in the fields of temperature measurement and spectrometry.

Position of pixels

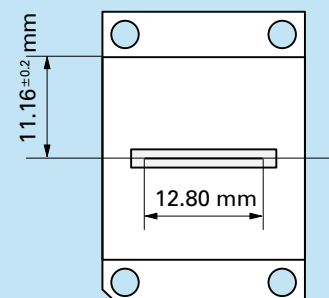
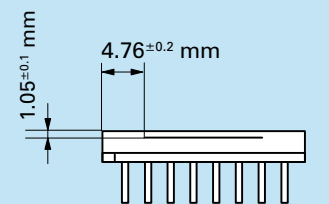

Optical specification										
Type	HPL 128-100	HPL 128I-100	HPL 128-500	HPL 128I-500	HPL 128-1000	HPL 128I-1000	HPL 256I-100	HPL 256I-500	HPL 256I-1000	
Pixel number	128	128	128	128	128	128	256	256	256	
Pixel width in μm	90	90	90	90	90	90	42	42	42	
Pixel length in μm	100	100	500	500	1000	1000	100	500	1000	
Pitch in μm	100	100	100	100	100	100	50	50	50	

Electro-optical specification ¹										
Type	HPL 128-100	HPL 128I-100	HPL 128-500	HPL 128I-500	HPL 128-1000	HPL 128I-1000	HPL 256I-100	HPL 256I-500	HPL 256I-1000	
Responsivity S_V in V/W	230000	540000	230000	540000	230000	540000	620000	620000	620000	
Noise voltage U_N in mV	0.7	0.8	0.9	1.2	1.1	1.9	0.7	0.9	1.1	
NEP in nW	3.0	1.5	3.9	2.2	4.9	3.5	1.1	1.4	1.8	
MTF ($R = 3 \text{ lp/mm}$)	0.6	0.6	0.6	0.6	0.6	0.6	0.6	0.6	0.6	
Uniformity ² of S_V in %	5	5	5	5	5	5	5	5	5	

¹ Typical values, rectangular chopping with 128 Hz, array temperature 25 °C, black body source temperature 400 °C, filter transmission 100 %.

² No defective elements.

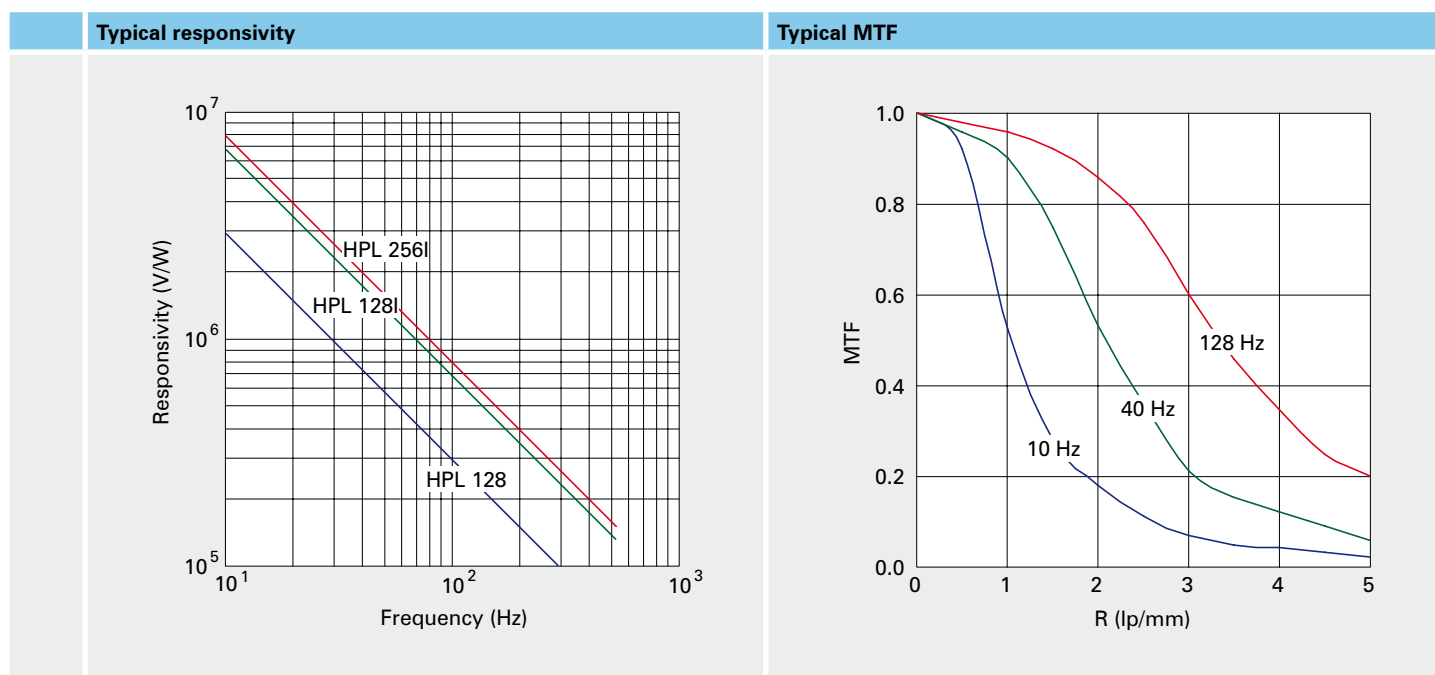

Maximum/minimum conditions ¹		
Parameter	Maximum/minimum value	Unit
VDD, VD2	-0.3 to 7	V
Digital inputs CLK, RES, VVR, VDR, VSH	-0.3 to VDD + 0.3	V
Chopping frequency f_{ch}	10 to 512	Hz
AD590+ to AD590-	-20 to 44	V
Analog output ²	± 5	mA
Maximum irradiance	50	mW/mm ²
Soldering temperature	300	°C
Storage temperature	-20 to 80	°C
Operating temperature	-15 to 70	°C

¹ All voltages refer to ground (pin 10, 15). ² Not short resistant.

Electrical parameters ¹				
Parameter	Minimum value	Typical value	Maximum value	Unit
VDD	4.75	5.0	5.25	V
VD2	2.4	2.5	2.6	V
Digital inputs, low voltage	0		0.3 VDD	V
Digital inputs, high voltage	0.7 VDD		VDD	V
Digital inputs, switching treshold		0.5 VDD		V
Digital inputs, leakage current			±1	μA
Current consumption		8		mA
AD590 operating voltage ²			30	V

¹ All Values for VDD = 5 V, VD2 = 2.5V. ² See data sheet of Analog Devices.

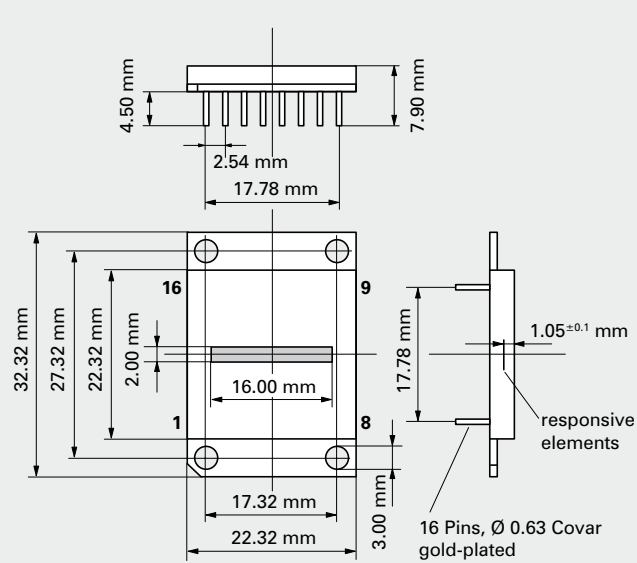
Pins			Package
Number	Name	Remark	
1	CLK	Input clock CLK (trigger on rising edge)	 <p>Dimensions: 4.50 mm, 2.54 mm, 17.78 mm, 7.90 mm, 32.32 mm, 27.32 mm, 22.32 mm, 2.00 mm, 16.00 mm, 16, 9, 17.78 mm, 1.05±0.1 mm, 8, 17.32 mm, 22.32 mm, 3.00 mm, 16 Pins, Ø 0.63 Cover gold-plated</p>
2	RES	Input clock RES (active low)	
3	VVR	Input clock VVR (active high)	
4	VDR	Input clock VDR (active high)	
5	VSH	Input clock VSH (active high)	
6	VD2	Operating voltage (+2.5 V)	
7	VDD	Operating voltage (+5 V)	
8	VD2	Operating voltage (+2.5 V)	
9	OUT	Analog signal output	
10	GND	Ground	
11	n.c.	not connected	
12	AD590+	Temperature sensor	
13	AD590-	Temperature sensor	
14	case	Case	
15	GND	Ground	
16	VDD	Operating voltage (+5 V)	

Connect pin 6 to pin 8 (VD2), pin 7 to pin 16 (VDD), pin 10 to pin 15 (GND).

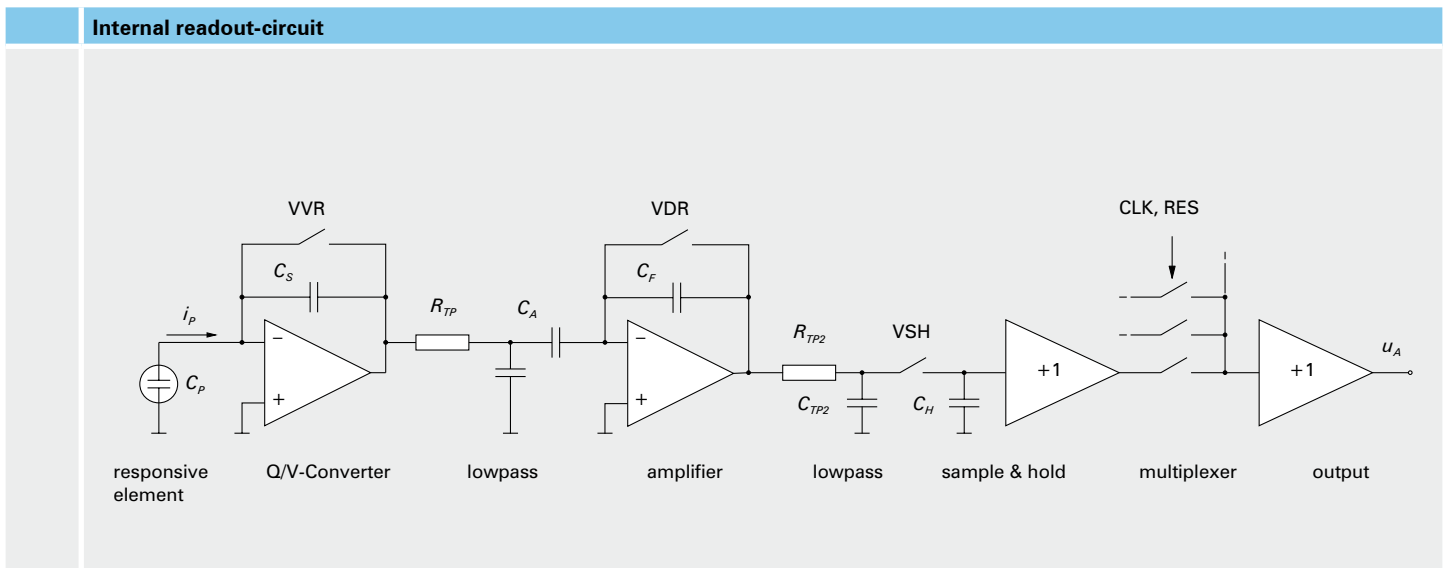

Clock parameters ¹					
Parameter	Relative value	Minimum value	Typical value	Maximum value	Unit
Chopping frequency ² f_{Ch}		10	128	512	Hz
Readout clock CLK $f_{CLK} = 2 \cdot f_{Ch} \cdot 268$	$1/t_{CLK}$	0	69	300	kHz
Reset clock low-impulse duration t_{RES}	$1/2 t_{CLK}$	1.8	7.5		μs
Clock VVR high-impulse duration t_{VVR}	$2 t_{CLK}$	7.5	30		μs
Clock VDR high-impulse duration ³ t_{VDR}	$28 t_{CLK}$	200	400		μs
Clock VSH high-impulse duration t_{VSH}	$1 t_{CLK}$	3.5	15		μs
Setting time at the output t_{out}				1	μs

¹ All values for VDD = 5 V, VD2 = 2.5V. ² $t_{Ch\ low} = t_{Ch\ high}$. ³ For $f_{Ch} = 512$ Hz t_{VDR} should be $56 \cdot t_{CLK} = 200 \mu s$.

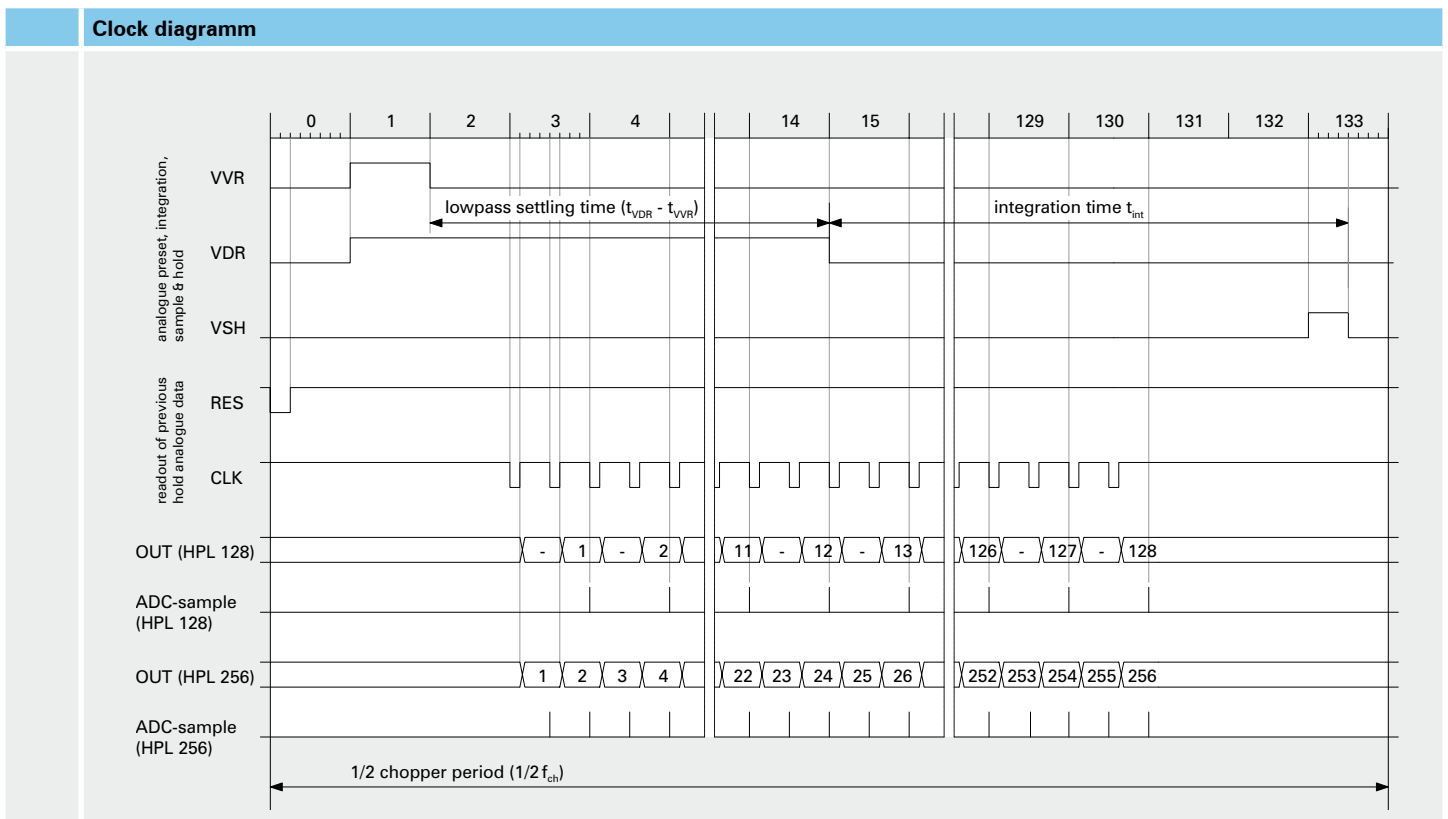

Right for modifications reserved.

11-2012, rev. 3